

MOST25 DA SERIES

— INSTALLATION AND USER GUIDE —

BRIDGING MEDIA, COMMUNICATION & LIFESTYLE WITH YOUR VEHICLE

mObridge

mObridge



CONTENTS

DISCLAIMER	4
WELCOME	5
OVERVIEW	6
Vehicle Compatibility	6
Kit Contents	6
DA1 Digital Pre-Amp MOST25	6
DA-G2.Standard MOST25 & DA-G2.Pro MOST25 Kits	6
Technical Specifications	8
HARDWARE INSTALLATION	9
System Layout	9
DA1 Digital Pre-Amp	9
DA-G2.Standard & DA-G2.Professional	10
Installation Guide	11
Wiring Harness	11
Remote Wakeup	11
DIP Switches	12
LED Status	14
GRAPHICAL INTERFACE OPERATION	14
Software Update	14
Speaker Mapping	17
Mono Inputs	18
Saving Setups & Presets	20

DISCLAIMER

mObridge makes every effort to try and keep the support and installation documentation up to date.

We do not reimburse or bear costs arising from installations should installation issues occur. mObridge can be contacted via email and also via its worldwide distribution network. We always recommend contacting the local distributor first, and although we endeavour to answer emails we receive in a timely manner, due to time zone differences we may not be able to respond immediately.

mObridge always recommends professional installation of these products as they are technically complex, involving optical fiber across multiple vehicle configurations and software versions within these vehicles.

In some cases, vehicles may require coding by specialist workshops and diagnostic equipment. mObridge always recommends allocating a number of hours to any installation, just in case any issues should arise.



AUSTRALIAN
DESIGNED &
ENGINEERED

WELCOME

Congratulations on your purchase of a mObridge MOST25 DA series preamp. mObridge prides itself on striving to develop and manufacture products to the highest engineering quality standards and seamlessly integrating these products with factory audiovisual systems.

The mObridge MOST25 DA series are some of the most advanced DSP aftermarket audio integration interfaces available for MOST25 based vehicles and come with an easy to use Windows and macOC Graphical Interface for setting up and tuning the MOST25 DA systems. This can be downloaded free from www.mobridge.us.

Features, depending on the MOST25 DA model, include TOSLINK output, channel mapping to 10 RCA output channels, 1024 point parametric graphic equalizer for each channel, as well as a 'master EQ', crossover type and crossover points for each speaker, crossover slope, individual speaker time alignment, phase adjustment, Q factor (both left and right), summing for subwoofers and centre channel upmixing. The user can also use the radio controls to change preset settings in the MOST25 DA for different tuning profiles.

As with all mObridge products, we have included a USB port for software upgrades, allowing for new features to be added as they come available. The MOST25 DA series can be updated by simply loading the latest software from our website and through the use of the DSP user interface.

The MOST25 DA series may also have system function upgrades available for purchase and download from time to time. These will also be available on our website.

We hope you enjoy your new enhanced listening experience!

OVERVIEW

VEHICLE COMPATIBILITY

The mObridge MOST25 DA series is compatible with specific BMW, Mercedes, Audi, Porsche, Mini, Jaguar, Landrover, Toyota and Aston Martin vehicles. Please refer to the website to see the complete compatibility list, www.mobridge.us/support

KIT CONTENTS

DA1 Digital Pre-Amp MOST25

The mObridge DA1 Digital Pre-Amp MOST25 kit contains the following items:

- / DA-G2 MOST25 unit
- / Power Loom
- / MOST Optical Cable Connection
- / Free software download from mObridge DSP PC Application on our website www.mobridge.us [This is not provided in the package contents]

DA-G2.Standard MOST25 & DA-G2.Pro MOST25 Kits

The mObridge DA-G2.Standard and DA-G2.Pro MOST25 kits contain the following items:

- / DA-G2 MOST25 unit
- / Power, Ground & Remote wiring harness
- / MOST 'T' piece harness
- / Female 2+0 MOST connector for harness extension
- / Male 2+0 shell for harness extension
- / Free software download from mObridge DSP PC Application on our website www.mobridge.us [This is not provided in the package contents]

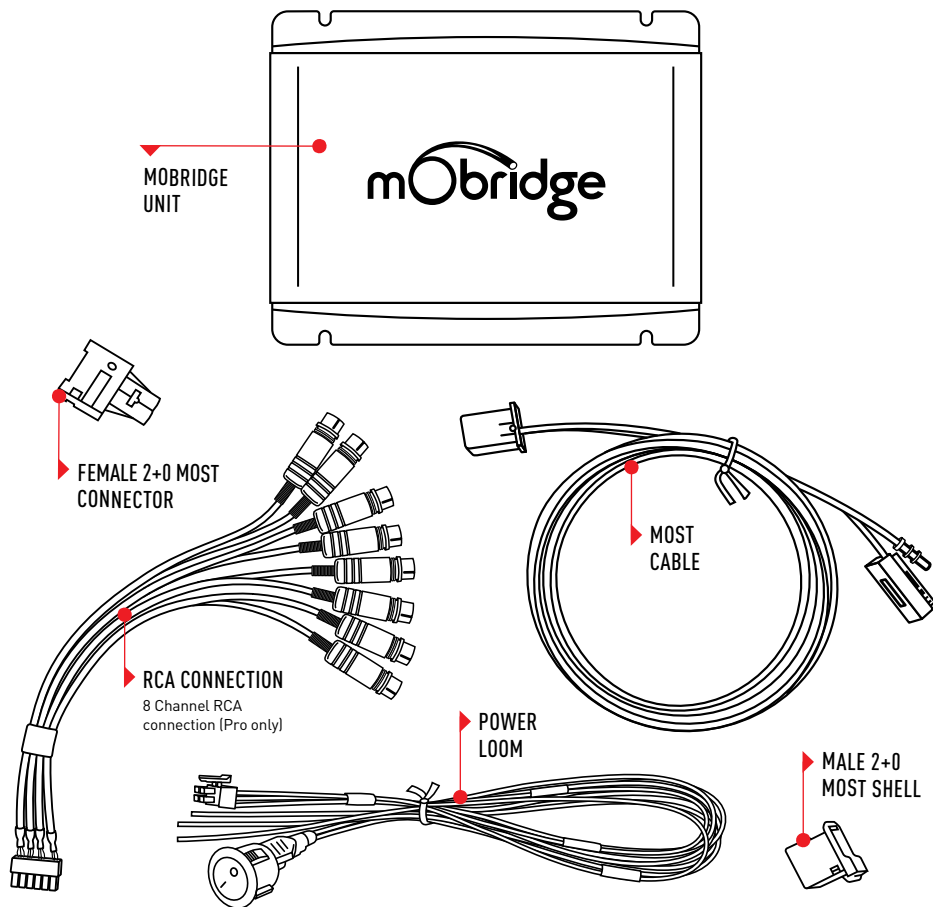

TECHNICAL SPECIFICATIONS

INPUT	
Digital Input	MOST25 Optical
OUTPUT	
Digital Outputs	TOSLINK (24bit 48kHz)
Frequency Response (Digital)	20Hz - 24KHz
Analog Outputs	10 Channels (RCA)
Output Voltage (Peak)	7.2
Output Voltage (RMS)	3.6V
Analog Output Type	Single-Ended
Signal-to-noise Ratio (Analog)	112dB
Frequency Response (Analog)	20Hz - 24KHz
THD+N @ -1dBFS	-107dBFS
Digital-Analog Converter	32bit 48kHz
Digital Signal Processor	32bit Blackfin Processor
POWER SUPPLY	
Current Consumption (Stand-by)	<3mA
Current Consumption (Operational)	300mA
Operational Voltage	8-22 Volts
Remote Turn on Output	Automatic
Remote Turn on Voltage	12V
Remote Turn on Current	500mA
OTHER	
Dimension	110mm x 80mm x 30mm
Weight	250g
Country of Origin	Australia

HARDWARE INSTALLATION

SYSTEM LAYOUT | DA1 DIGITAL PRE-AMP

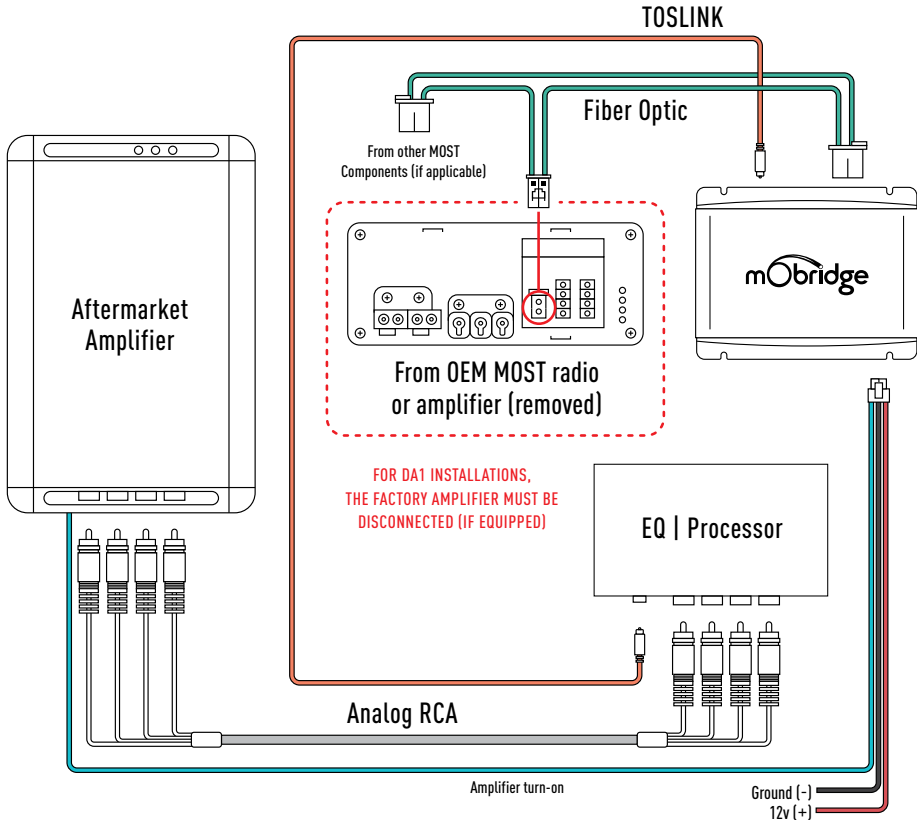

SYSTEM LAYOUT | DA-G2.STANDARD & DA-G2.PROFESSIONAL

FOR DA-G2 INSTALLATIONS, THE FACTORY AMPLIFIER
MUST BE DISCONNECTED (IF EQUIPPED)

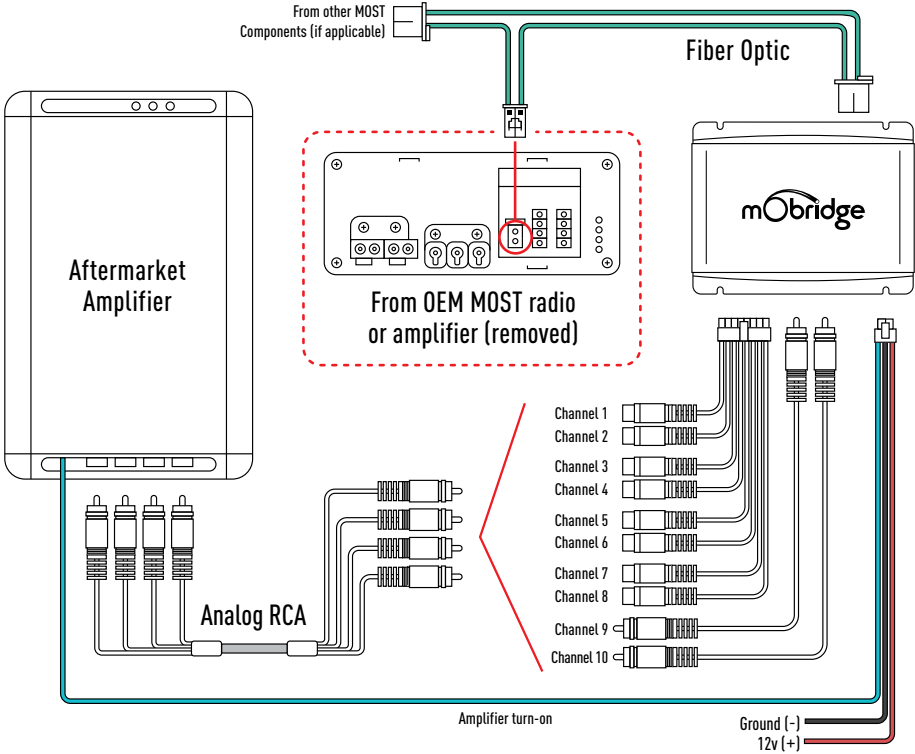

INSTALLATION GUIDE

WIRING HARNESS

- 01** For MOST25 DA installations, the installation process changes depending on whether the vehicle has an amplifier, and also if it has MOST fiber optic presently installed.
- a** For vehicles with a fiber amplifier, the factory amplifier must be removed and the MOST25 DA unit can be installed in its place. Connect the OEM fiber previously connected to the amp, directly into the MOST25 DA unit.
- b** For vehicles without an OEM amplifier or MOST fiber, use the supplied optic extension and connect from the fiber port behind the radio to the MOST fiber port on the MOST25 DA.
- c** For vehicles without an OEM amplifier but still equipped with MOST fiber, disconnect the fiber from the radio and connect it to the supplied 'T' piece harness. Connect one side of the 'T' piece harness to the MOST25 DA and then connect the remaining plug back to the radio unit to add the MOST25 DA to the MOST loop.
- * NOTE:** with options (b) and (c), you must reprogram the system to use the external amplifier for the MOST25 DA to operate properly. Use the mObridge MOST25 OBD programmer to reprogram the system.

02 Connect the wiring harness to the POWER socket on the MOST25 DA.

03 Connect the desired audio output(s) to the MOST25 DA: (Note: both Analog and Digital outputs can be used simultaneously).

a If using analog RCAs for the signal to the amplifier, connect the provided RCA output harness to the ANALOG OUT port on the MOST25 DA.

b If using the digital TOSLINK for the signal to the amplifier, connect a TOSLINK cable to the TOSLINK OUT port on the MOST25 DA.

REMOTE WAKEUP

The MOST25 DA kits come with remote wake-up functionality. The remote wake-up wire (Blue) is used to power on the amplifier with the vehicle's accessory power at the same time as the rest of the audio system. We recommend this be installed by a professional installation technician.

DIP SWITCHES

There are 6 dip switches on the MOST25 DA unit. These switches are used to set which head unit configuration is in your vehicle to provide seamless integration with your MOST25 DA unit.

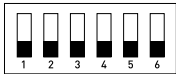
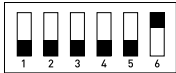
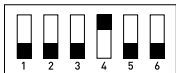
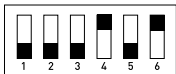
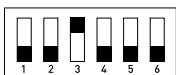
SWITCH SETTINGS	VEHICLE	RADIO	NOTES
	Porsche	PCM 2.0/2.1 (2003-2009)	
	Porsche	PCM3.x (2009-2014)	mObridge will not be held responsible for any echo issues experienced in the PCM3.x systems. These radios have a very 'brittle' window of echo cancellation in its Bluetooth processing. Many factors can contribute to the echo issues in these vehicles such as speaker placement and crossover selection.
	Audi	MMI 2G	
	Audi	MMI 3G	The MMI3G system must be coded for the external amplifier.
	Mercedes	Any 2003 - 2008	The W211 E Class from 2003-2008 and the SLK 171 from 2005-2008 with the NTG2.0 system are not compatible.

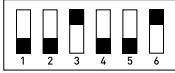
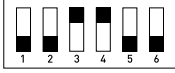
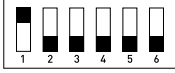
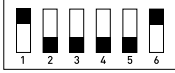
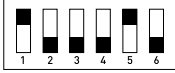
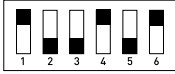
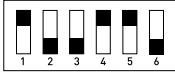
SWITCH SETTINGS	VEHICLE	RADIO	NOTES
	Mercedes	NTG 2.5/4.0.4.5/4.7	
	BMW, Mini & Toyota	All (Except BMW E65)	The BMW E65 with the ASK system is not compatible.
	Landrover	6CD (2005 - 2010)	
	Landrover	Touchscreen (2010 - 2017)	
	Jaguar	Touchscreen (2010 - 2017)	The vehicle must be coded by the dealership if it does not contain the factory MOST25 amplifier.
	Aston Martin	G1	
	Aston Martin	G2	

LED STATUS

LED	LED STATUS	INDICATION
A (Leftmost)	Flashing	Audio Processing
B	Solid	MOST25 Link
C (Rightmost)	Solid	Master Sync

GRAPHICAL INTERFACE OPERATION

The mObridge DSP GUI (Graphical User Interface) can be downloaded from www.mobridge.us and can be used in both online and offline mode. However, in order to 'Map the channels,' you will need to be connected to the MOST25 DA with power connected too. Offline mode allows you to configure Graphic EQ settings and store them for later fine-tuning in the car if desired. We recommend all tuning be done with a 'Live' system because this way you can hear all changes being made in real-time.

SOFTWARE UPDATE

The mObridge MOST25 DA series can be software updated via its USB connection and use of the mObridge DSP software interface that runs on Windows and mac Os. The mObridge DSP GUI can be downloaded from support on our website www.mobridge.us/support

Once the GUI has been installed, the latest MOST25 DA software can be applied. The GUI can perform software updates either using the online updater,

or you can download the latest software for an offline update at www.mobridge.us/support

The mObridge MOST25 DA unit will need to be connected in the car and powered up for the unit to be updated. Once it has connected to the DSP GUI the user will be presented with the following screen (**figure 01**). Please note that certain features are only available in the DA-G2.Pro MOST25 model, if you have a DA1 Digital Pre-Amp MOST 25 or a DA-G2.Standard MOST25 these features may not be available.

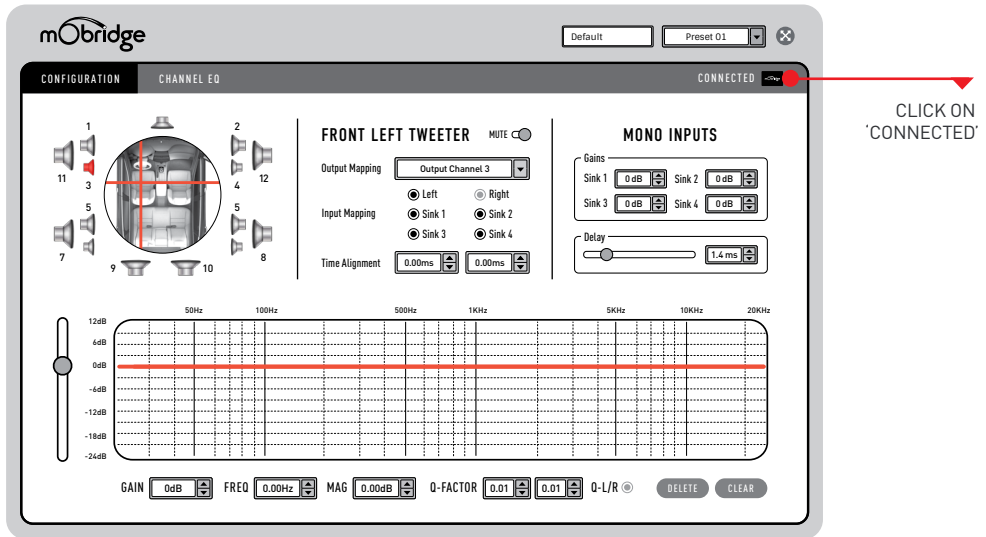

FIG 01 MOST25 DA is connected to the DSP GUI

Once the MOST25 DA is connected via the GUI we can just click on the 'Connected" button in the to right-hand corner and this will bring us to the update page as seen on the following page (figure 02).

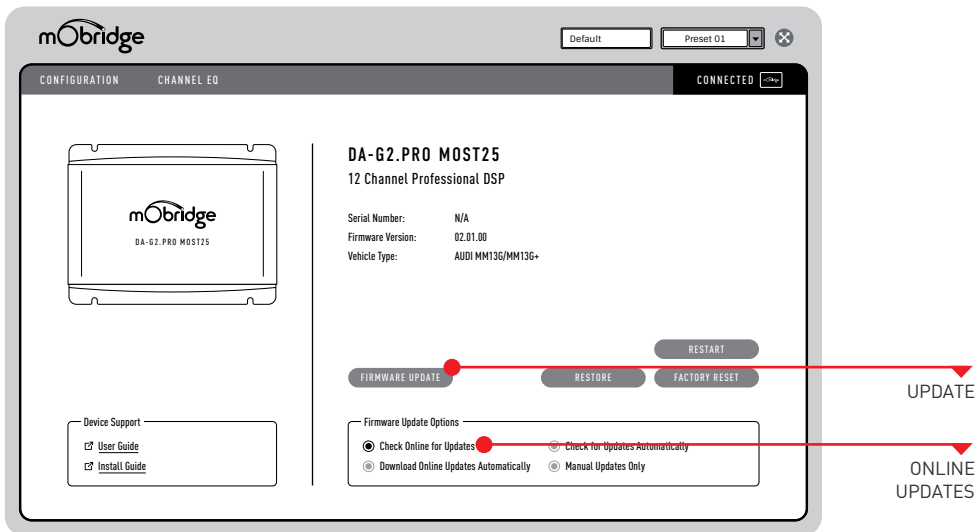

FIG 02 Update Page

If performing an online update, make sure the 'Check Online for Updates' option is ticked and then press the 'Firmware Update' button. This will automatically check for the latest software update for the connected device and begin the upgrade process.

If performing an offline update, make sure the 'Check Online for Updates' option is unticked and then press the 'Firmware Update' button. This will

open a window where you can select the new MOST25 DA firmware file to update to and the update procedure will begin.

Once the update has completed, the MOST25 DA unit will reboot and start the system again. Sometimes it is a good idea to let the car sleep after the firmware upgrade as some MOST systems do not like ECU's resetting on the MOST bus.

SPEAKER MAPPING

Once the MOST25 DA unit is connected to the mObridge DSP application, you will see the below screen (figure 03).

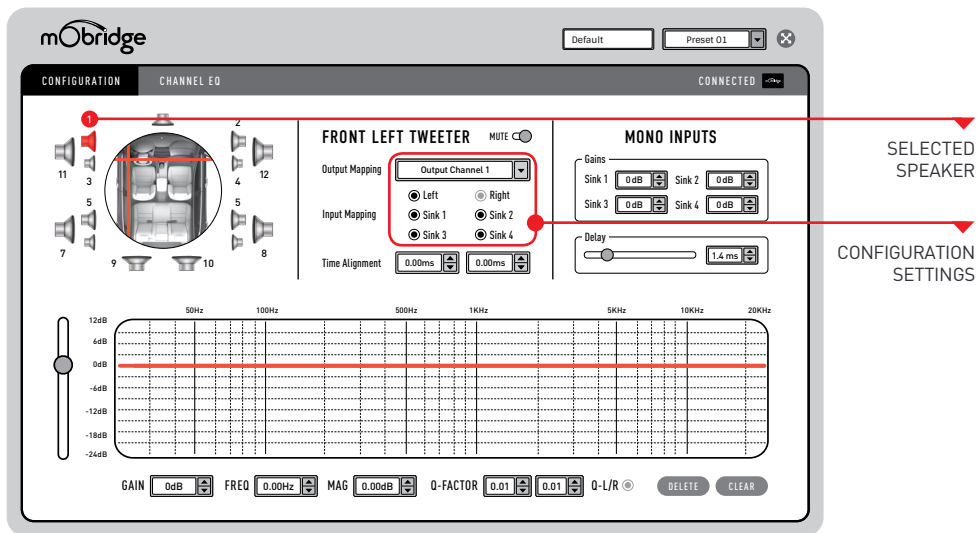

FIG 03

Configuration Page

This configuration screen will allow you to configure the channels for the correct mapping of your particular system.

First select a speaker from the image of the vehicle in the top left corner, then select an output mapping

from the drop-down menu in the middle of the screen to select the channel output you have connected for that particular speaker. Repeat this for each speaker and its corresponding output channel.

When running a component speaker system with a passive crossover, only select one of the speakers in the cluster. It is not important which speaker is chosen, as this is only the mapping stage. Crossover settings will allow for correct settings for this type of speaker system.

Next, you will need to allocate the appropriate input mappings to each speaker. For each speaker, simply select the speaker image in the top left corner, and then click the appropriate 'Input Mapping' options for each speaker. If multiple input mappings are selected, these sources will be combined and summed.

MONO INPUTS

After mapping your speakers, you can then adjust the mono input gains and delay using the "Mono Inputs" panel which will be displayed on the right-hand side of the configuration tab (figure 04).

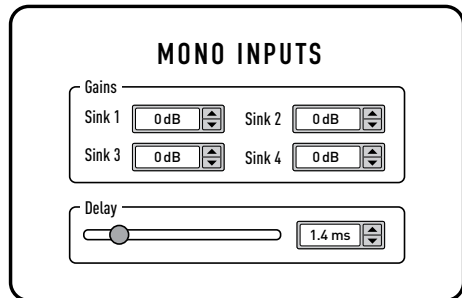

FIG 04

Mono Input adjustments

PHONE, NAV, PDC AND CHIME GAIN ADJUSTMENTS

This can be used to independently adjust the gains of the input sinks such as phone, navigation, PDC, and chimes. Each manufacturer has different configurations for their mono inputs so please reference the table below when adjusting your phone, nav, pdc or chime gains.

VEHICLE	PHONE	NAV	PDC	CHIMES	VOICE
BMW	Sink 1	Sink 2	Sink 4	Sink 3	Sink 2 (same as Nav)
Audi	Sink 1	Sink 2	NA	NA	Sink 3
Porsche	Sink 1	Sink 2	NA	NA	Sink 3
Mercedes	Sink 1	Sink 2	NA	NA	Sink 3
Landrover	Sink 2	Sink 2 (same as Tel)	Sink 3	Sink 4	Sink 2 (same as Tel)
Jaguar	Sink 2	Sink 2 (same as Tel)	Sink 3	Sink 4	Sink 2 (same as Tel)
Aston Martin	Sink 1	Sink 2	Sink 3	Sink 4	Sink 2 (same as Nav)
Toyota	Sink 1	Sink 2	Sink 4	Sink 3	Sink 2 (same as Nav)
Mini	Sink 1	Sink 2	Sink 3	Sink 4	Sink 2 (same as Nav)

DELAY

The delay slider can be used to fine-tune the mono input processing delays in your mObridge device. This can help alleviate echo issues in certain vehicles while using your mObridge device to play audio on phone calls. The delay will be active on all mono inputs.

SAVING SETUPS & PRESETS

The MOST25 DA will automatically save setups upon shutdown of the MOST system. This needs to happen 'gracefully' meaning the car needs to go to sleep on its own, the user cannot just pull power from the unit as this will not work.

The MOST25 DA has four different presets and these can be tuned individually. The channel mapping will remain across all four presets and will also apply default filter setups to the speakers to avoid speaker damage. These can be selected with the drop-down menu in the top right corner as shown below (figure 05).

The screenshot shows the MOST25 DA software interface. At the top, there is a menu bar with 'File', 'Options', 'Tools', and 'Help'. Below the menu bar, there is a 'Save As' dropdown menu. The main window is titled 'CHANNEL EQ' and is divided into several sections:

- FRONT LEFT TWEETER:** Includes a speaker diagram, 'Output Mapping' (set to 'Output Channel 1'), 'Input Mapping' (radio buttons for Left, Right, Sink 1, Sink 2, Sink 3, Sink 4), and 'Time Alignment' (0.00ms).
- MONO INPUTS:** Includes 'Gains' for Sink 1, Sink 2, Sink 3, and Sink 4 (all set to 0dB), and a 'Delay' slider (set to 1.4 ms).
- Frequency Response Graph:** A graph showing frequency response from 50Hz to 20KHz. The y-axis ranges from -24dB to 12dB. A red horizontal line is drawn at 0dB.
- Bottom Controls:** Includes 'GAIN' (0dB), 'FREQ' (0.00Hz), 'MAG' (0.00dB), 'Q-FACTOR' (0.01), 'Q-L/R' (radio buttons), 'DELETE', and 'CLEAR' buttons.

Annotations on the right side of the image:

- A red arrow points from the 'Preset 01' dropdown menu to the text 'PRESET NUMBER'.
- A red arrow points from the 'Save As' dropdown menu to the text 'SAVE SETTINGS'.

FIG 05

Saving tuned settings

You can save a backup of all of your presets by simply clicking the 'File Button' on the top menu bar and then 'Save As' as shown in the above screen. This will save a backup of your setup across all four presets and this file can be used to load in saved settings.

It is also possible to pull these presets up using specific commands in the headunit of your vehicle. This varies depending on your vehicle make and head unit system. Please check the support documentation on the mObridge website to find the vehicle-specific instructions.

If there are no vehicle-specific instructions for your vehicle make, the preset can generally be changed using the Logic7 Surround controls as shown in the images below (figure 06 & 07).

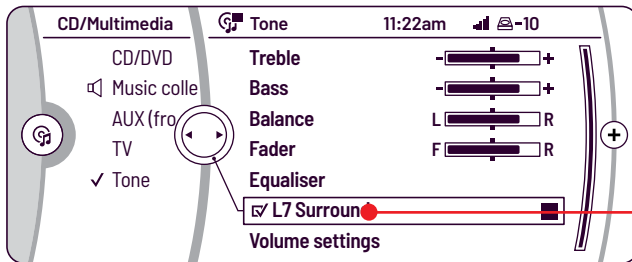

FIG 06 Using L7 Surround Mode to change presets

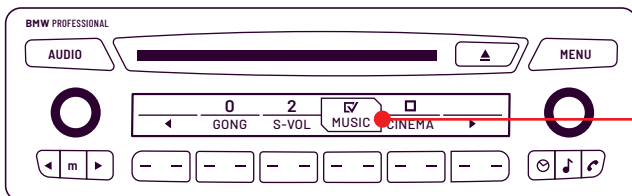

FIG 07 Using Professional Radio Surround Modes to change presets

MOBRIDGE.US

CONTACT US

PHONE +61 3 9465 5997 / INQUIRIES sales@mobridge.com.au

MOST



AUSTRALIAN
DESIGNED &
ENGINEERED